

NEW!

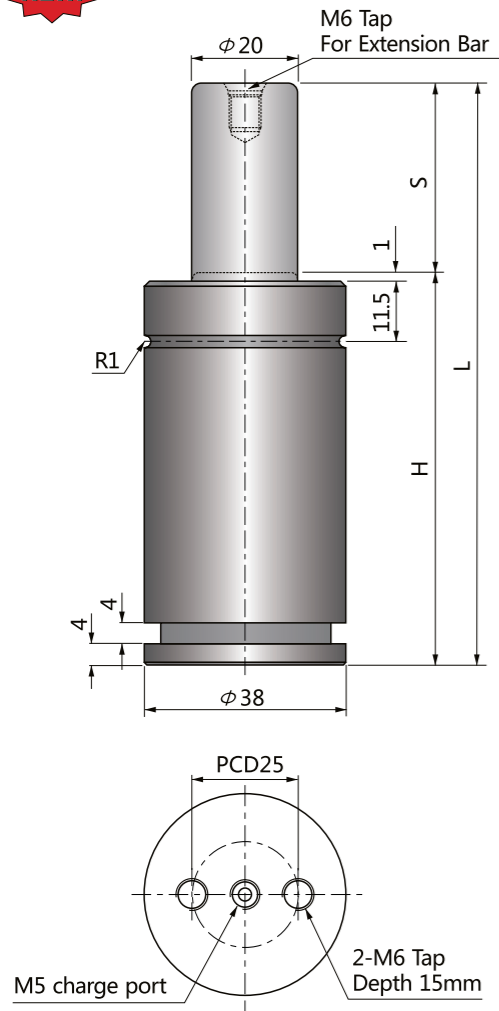

슈퍼 콤팩트 실린더 Super Compact Cylinders

NTT타입 특성은 NT타입과 동일하나, 강력한 장착을 위하여 고정용 탭의 치수가 한 단계 크며 나사산의 깊이도 더욱 긴 16mm입니다. NTT1000부터 배관연결이 가능합니다. 직경 32mm(350kgf)부터 150mm(9500kgf)까지 공급됩니다.

NTT type has same characteristics as NT type but has bigger tap size and 16mm thread dept for more secure mounting. Available hose connection from NTT1000. The size starts from 32mm(350kg) to 150mm(9500kg).

코드 CODE	스트로크 S	H	L	FORCE(kgf)	
				초기하중 Fi	최대하중 Ff
NTT500-10	10	50	60	500	800
NTT500-13	13	53	66		
NTT500-16	16	56	72		
NTT500-19	19	59	78		
NTT500-25	25	65	90		
NTT500-32	32	72	104		
NTT500-38	38	78	116		
NTT500-50	50	90	140		
NTT500-63	63	103	166		
NTT500-75	75	115	190		
NTT500-80	80	120	200		
NTT500-100	100	140	240		
NTT500-125	125	165	290		

주의 : 배관연결형 사용불가
Not available Hose-connection

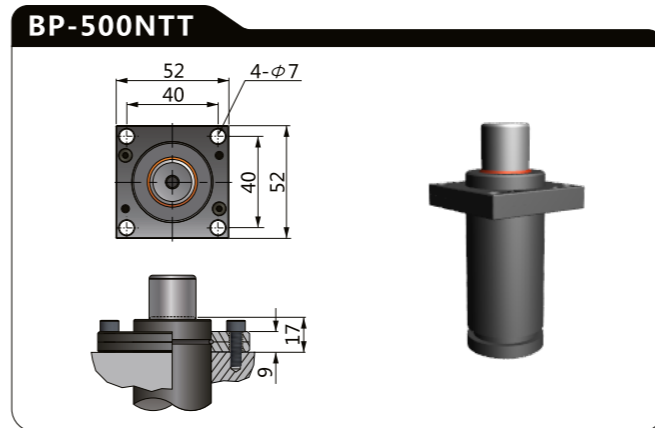
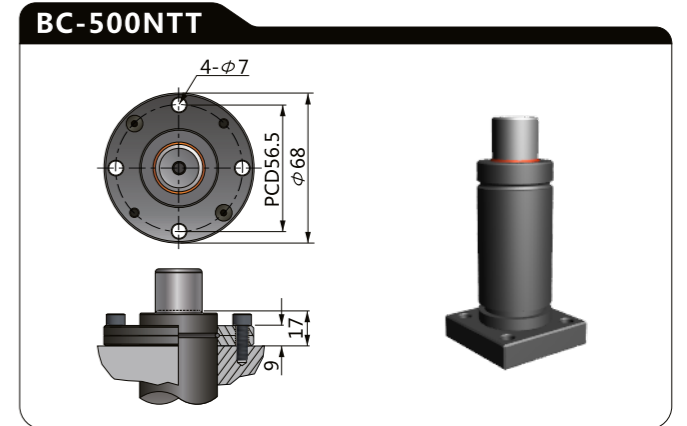
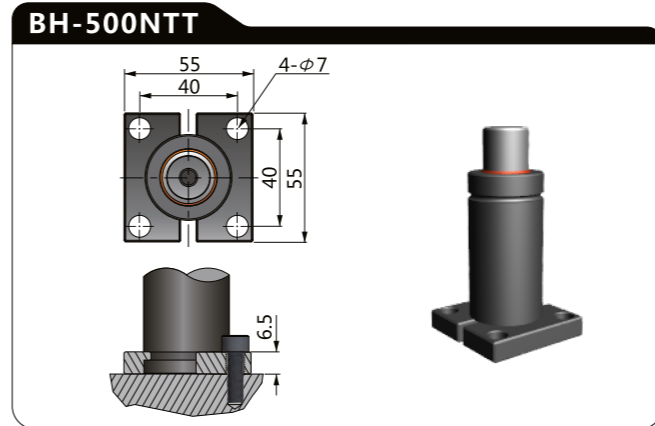

주문방법 Ordering

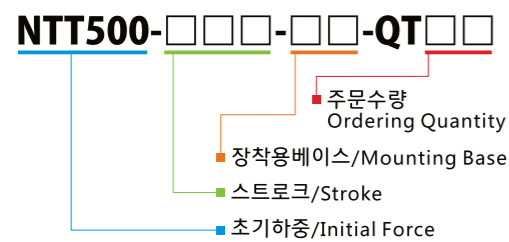

예) NTT500-050-BP-QT04

스트로크 구간별 스프링하중 Spring Force - Stroke Diagram

